

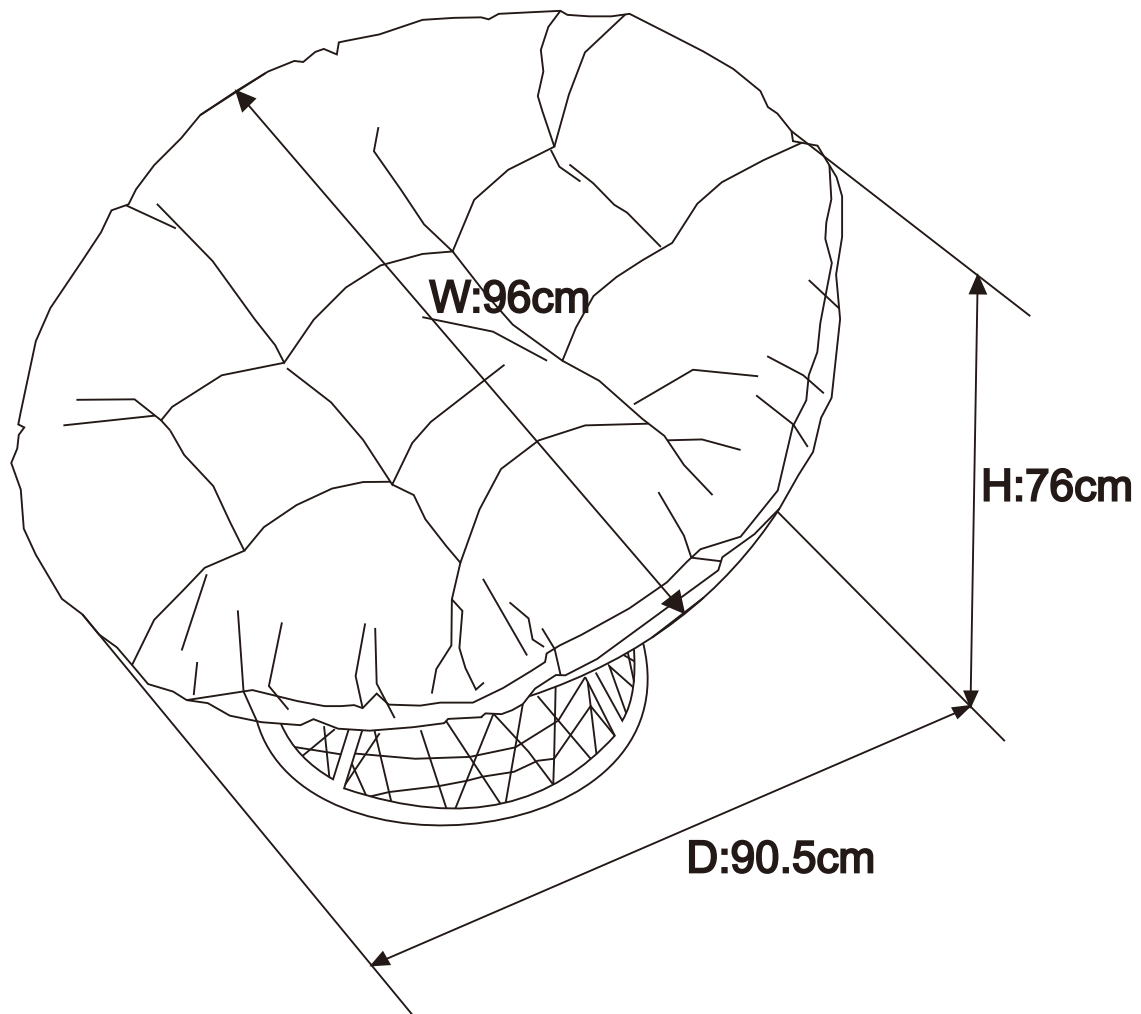

LIVING & CO[®]

Swivel Chair



INSTRUCTION MANUAL

AFTER SALES SUPPORT

 (NZ) 0800 422 274

Important Safety Instructions

Semi-tighten each bolt during assembly; ensure all bolts are tightened when fully assembled

Always place the product on a flat, steady and stable surface

Assembly Details

40 MIN

Approximate Assembly Time



2 Persons of Assembly

FLOOR AREA
2.0M x 2.0M



Required Assembly Space

Tip before you start

1. Please check that all parts are present before you start the assembly of your furniture.
2. For ease and speed of assembly, we recommend that before you commence each step of the assembly, that you identify all the parts required for that step.
3. For larger items, please ensure that you have sufficient space and people (as indicated on page 1) to assemble your product safely.
4. We recommend that, where possible, all items are assembled near to the area in which they will be placed in use, to avoid moving the product unnecessarily once assembled.
5. For the protection of your furniture, we recommend that the product is placed on a protected surface during assembly to prevent any damage.
6. During assembly please take care not to over-tighten any fittings, as this may damage the product. Do not use power tools.
7. Always place the product on a flat, steady and stable surface.
8. Do not stand on the product. Do not use the product as a stepladder.
9. This product is intended household use only as it is a non-industrial product.
10. Please use caution and care when lifting the product to avoid personal injury and/or product damage.

Care and maintenance

WICKER CARE INSTRUCTIONS







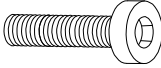

- To clean wicker, wash down regularly with mild soapy water and rinse with fresh water. Hose regularly with fresh water to remove airborne contaminants.
- Our wicker style furniture and cushions contain a UV coating to protect against deterioration. Some fading will occur over time. When it is cold, the weave may become stiffer than normal. When hot, the weave will become more elastic. Wicker style furniture will revert to its normal elasticity, once the temperature stabilises.
- We recommend storing undercover and using furniture covers when not in use and for protection during the winter months.

CUSHION CARE INSTRUCTIONS

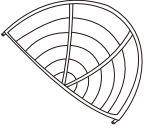
- Our cushions contain a UV treatment to protect them against deterioration. Some fading will occur over time.
- To clean cushions wash with mild soapy water and rinse thoroughly with fresh water.
- To avoid stains, remove spills promptly.
- Do not use solvent type cleaners.
- Do not machine wash, dryclean or tumble dry.
- Never store cushions when wet.
- We recommend that all cushions are stored inside to extend their life.

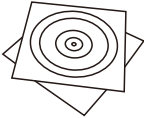
We recommend storing furniture under cover, out of direct sunlight and using furniture covers when not in use and for protection during the winter months.

Part name

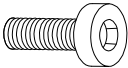
A		1	G	 M6*35	4
B		1	H		4
C		1	I		12
D		1	J		1
E		1	K		1
F	 M6*15	8			

Assembly

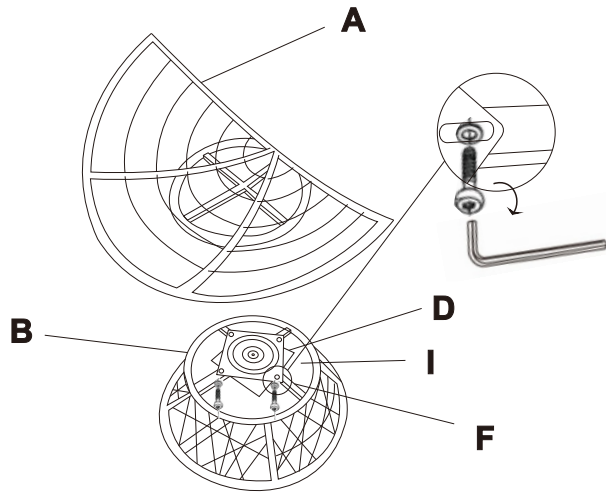

1

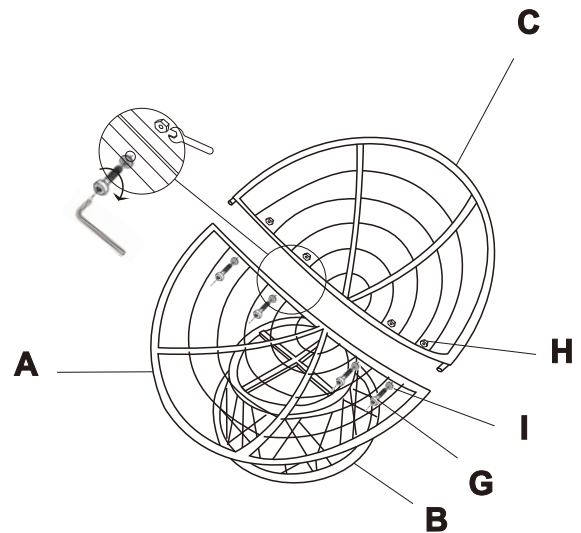

2

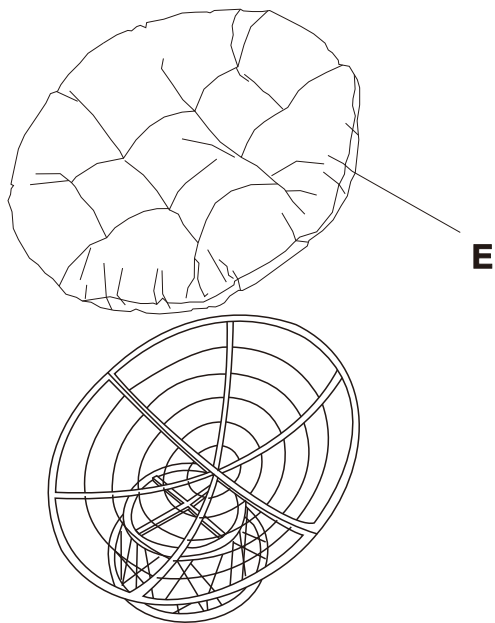

3

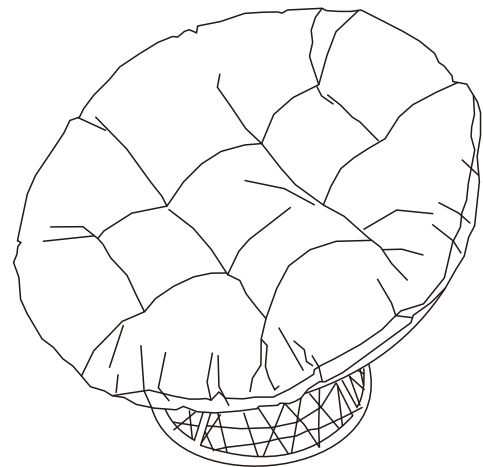

4



LIVING & CO[®]

Warranty

We pride ourselves on producing a range of quality products that are both packed with features and completely reliable. We are so confident in our products, we back them up with one year warranty.

Now you too can relax knowing that you are covered.

Customer Helpline NZ: 0800 422 274
This product is covered by one year warranty
when accompanied by proof of purchase.