

LIVING & CO[®]

Side Table with Removable Lid White

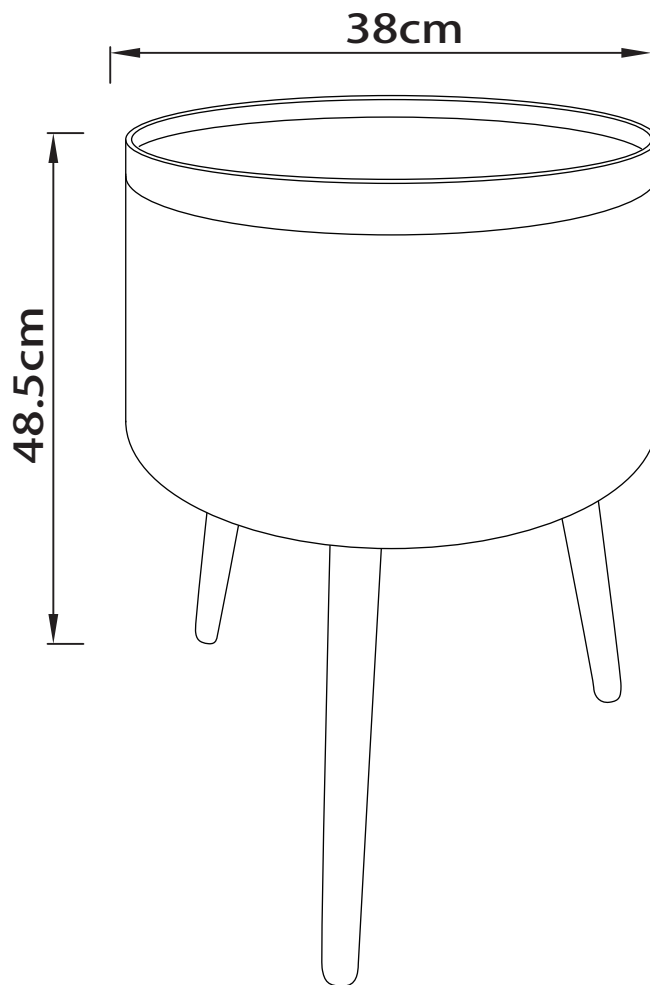

INSTRUCTION MANUAL
MAX WEIGHT:5KGS

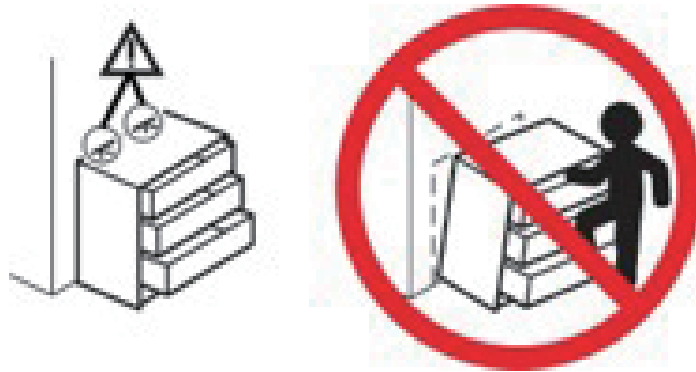

Important Safety Instructions



Serious or fatal crushing injuries can occur from furniture tip-over. Use of tip-over restraints may only reduce but not eliminate the risk of tip-over. To help prevent tip-over:

- Place heaviest items in the bottom drawers.
- Unless specifically designed to accommodate, do not set TVs or other heavy objects on top of this product.
- Never allow children to climb or hang on drawers, doors or shelves.
- Never open more than one drawer at a time.

Assembly Details

<p>10 MIN</p> <p>APPROXIMATE ASSEMBLY TIME</p>	<p>1 PERSON ASSEMBLY</p> 	<p>FLOOR AREA 1.5M x 1.5M</p>  <p>REQUIRED ASSEMBLY SPACE</p>

Tips before you start

1. Please check that all parts are present before you start the assembly of your furniture.
2. For ease and speed of assembly, we recommend that before you commence each step of the assembly, that you identify all the parts required for that step.
3. For larger items, please ensure that you have sufficient space and people (as indicated on page 1) to assemble your product safely.
4. We recommend that, where possible, all items are assembled near to the area in which they will be placed in use, to avoid moving the product unnecessarily once assembled.
5. For the protection of your furniture, we recommend that the product is placed on a protected surface during assembly to prevent any damage.
6. During assembly please take care not to over-tighten any fittings, as this may damage the product. Do not use power tools.
7. Always place the product on a flat, steady and stable surface.
8. Do not stand on the product. Do not use the product as a stepladder.
9. This product is intended for indoor, household use only as it is a non-industrial product.
10. Please use caution and care when lifting the product to avoid personal injury and/or product damage.

Care and maintenance

- ✓ Please periodically check all fittings and re-tighten as necessary.
- ✓ To clean your item, please use a damp cloth and wipe clean.
- ✓ Never allow any kind of liquid to remain on your furniture. Absorption can cause wood to warp or finishes to de-laminate.
- ✓ Please do not place hot items (eg. hot drinks) directly on to the surface.
- ✓ Please do not drag and pull your furniture.

Part Name

HARDWARE LIST

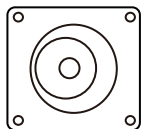

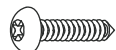

X3
D

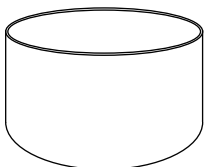

X12
E

PARTS LIST

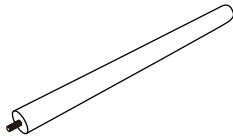
						
A	1pc	B	1pc	C	3pcs	

Assembly

STEP 1

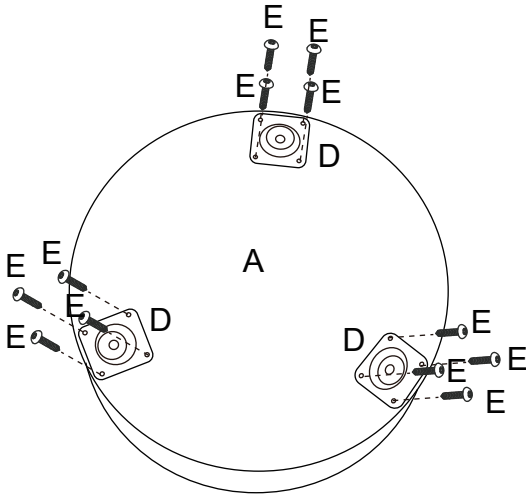

STEP 2

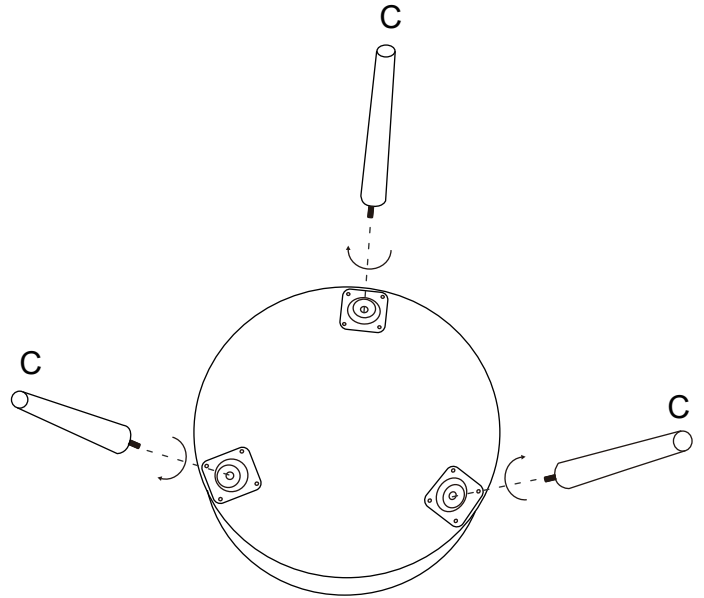

STEP 3

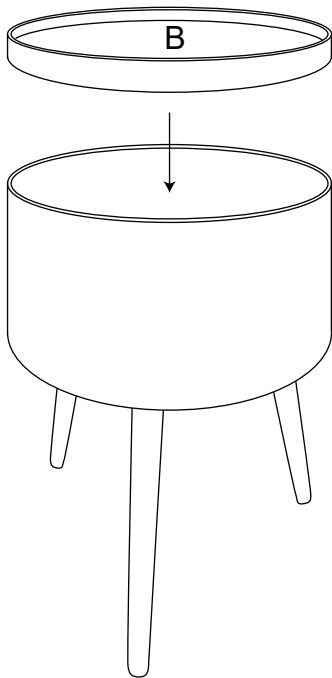

STEP 4

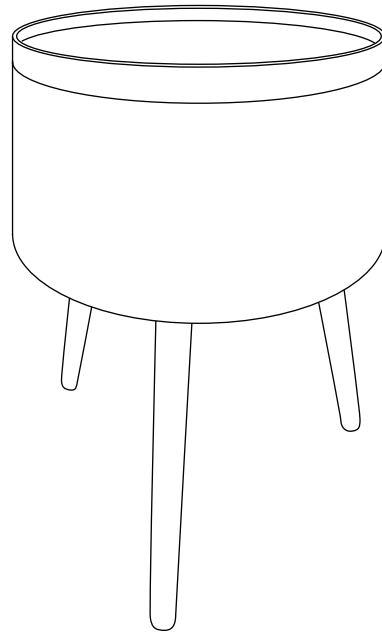



STOP

BEFORE
RETURNING
TO STORE

Read the manual.
It will help you get the
best out of your product.

Still have questions?
Call After Sales Support

0800 422 274

LIVING & CO[®]

Warranty

We pride ourselves on producing a range of quality home furniture that are both packed with features and completely reliable.

Customer Helpline NZ: 0800 422 274

This Product is covered by one-year warranty when accompanied by proof of purchase.