



# Chase Select™ /LX™ Child Restraint System

## Owner's Manual

Keep for future use

# Exclusive RightFit Belt Path

## Child Requirements

10-49,8 kg

22-110 lbs

71-145 cm

28-57 in

Para instrucciones en Español,  
llamar al: 1-800-233-5921

## **WARNING:**

To reduce the risk of serious injury  
or death, read this owner's manual prior  
to installing and using this child restraint.

## More children are killed every year as passengers in car crashes than by any other type of injury.

To reduce the risk of **SERIOUS INJURY** or **DEATH**, read this owner's manual and your vehicle owner's manual before installing and using this child restraint. Using a child restraint makes a big difference. By properly using this child restraint and following these instructions (and the instructions that accompany your vehicle), you will greatly reduce the risk of serious injury or death to the child from a crash. Do not be misled by the commonly used term "safety seat"; no restraint system can prevent all injuries in all crashes. Many properly restrained adults and children are injured in motor vehicle crashes, including relatively minor crashes. A properly used child restraint is the best way to minimize injuries to the child and to increase the chances for the child's survival in most crashes.

### U.S. REGULATORY NOTICE

*This child restraint meets all applicable requirements of Federal Motor Vehicle Safety Standard 213.*

### CANADIAN REGULATORY NOTICE (Model numbers ending in "C".)

*This child restraint meets all applicable requirements of Canadian Motor Vehicle Safety Standards CMVSS 213 and 213.2.*

### Child Requirements

- No restraint can guarantee absolute protection from injury in every crash.
- This child restraint is designed for use by children in forward-facing and booster modes.
- To use this child restraint properly, children **MUST** meet weight/size specifications as follows:

#### For 5-pt Harness Use

- The child weighs 10 – 18 kg (22 – 40 lbs).
- The child is between 71 – 127 cm (28 – 50 inches) tall **AND** the tops of his/her ears are at, or below, the child restraint headrest.
- Child is one year old or older.

#### For Booster Use

- The child weighs 18 – 49.8 kg (40 – 110 lbs).
- The child is between 110 – 145 cm (43.3 – 57 inches) tall **AND** the tops of his/her ears are at, or below, the child restraint headrest.
- Child is four years old or older.

## Table of Contents

### Important Information

Warnings.....	2
Safe Practices .....	8
Motor Vehicle/Aircraft Usage.....	8
Recall Information for U.S. Customers .....	9
Public Notice for Canadian Customers .....	9
LATCH Information .....	9
Care and Cleaning .....	10
Visual Glossary .....	12

### Internal 5-pt Harness Use

Installation Checklist .....	15
Installation with Lower Anchor Connectors .....	16
Installation with Seat Belt .....	19
Securing the Child .....	22
Removing the Child .....	24
Positioning the Harness Strap... ..	25
Positioning the Crotch Strap ....	27



### Booster Use

When to Put Your Child in a Booster Seat .....	28
Booster Installation Checklist....	31
Converting into a Booster Seat..	32
Shoulder Belt Routing .....	36

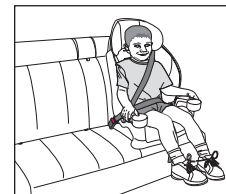

### General Information

Leveling the Booster Seat .....	37
Installing the Cup Holders .....	37
Removing Seat Pad .....	38
Securing Your Child Restraint in Aircraft .....	39
Installing Child Restraint in Aircraft.....	39
Replacement Parts.....	41
Limited Warranty.....	43

### Symbol Legend



**Airbag Symbol** – Alerts you to important information about airbag safety.



**LATCH Symbol** – Alerts you to important information about LATCH safety.



**Tether Anchor Symbol** – Alerts you to important information about tether anchor safety.

# **⚠WARNING**

## **Air Bag Warnings**

- **DO NOT** use this restraint in the front seat of a vehicle equipped with an air bag. Air bags may cause serious injury or death to children 12 and under. If your vehicle has an air bag, refer to your vehicle owner's manual for child restraint installation.
- If the rear seat of your vehicle is equipped with side air bags, refer to the following information for proper usage.  
**Vehicles built prior to the 2002 model year:**  
**DO NOT** use this restraint in a vehicle seating position equipped with a side air bag unless authorized by the vehicle manufacturer.  
**Model year 2002 and newer vehicles:**  
Refer to your vehicle owner's manual before placing this restraint in a seating position equipped with a side air bag.
- **DO NOT** place any objects between the restraint and the side air bag, as an expanding air bag may cause the items to strike the child.

*The back seat is the safest place for children 12 and under.*

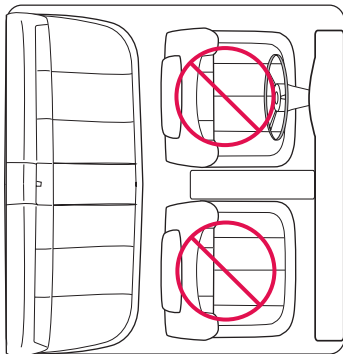

# **⚠WARNING**

## **General Warnings**

- Failure to follow installation instructions can result in the child striking the vehicle's interior during a sudden stop or crash. Serious injury or death may result. These instructions and the instructions in your vehicle owner's manual must be followed carefully. If there is a conflict between the two, the vehicle owner's manual regarding child restraint installation must be followed.
- **NEVER** leave child unattended.
- **DO NOT** use child restraint if it is damaged, broken, or missing parts.
- **DO NOT** use this restraint if it has been involved in a crash. It must be replaced.
- **NEVER** use this child restraint without the headrest installed.
- **NEVER** use this child restraint rear-facing.

## **Location Warnings**

- **ALWAYS** read and follow exactly the instructions that accompany your vehicle and child restraint.
- According to statistics, children are safer when properly restrained in a rear seating position than in the front seating position. Generally, the center rear position is safest and should be used, if available.
- Some child restraints do not fit all vehicles or all seating locations. There are many thousands of combinations of vehicle makes, models, child restraint configurations, seat belt designs, and seat cushion shapes. The easiest way to determine whether the child restraint is suitable for a particular seating position is to check for a tight installation. If the child restraint cannot be properly installed, **DO NOT** use the child restraint. Consult vehicle owner's manual, try a different seating location, or call Evenflo.
- **ONLY** use this child restraint on **forward-facing vehicle seats**. **DO NOT** use this restraint with vehicle seats that face the rear or side.
- **ONLY** use this child restraint on vehicle seats with backs that lock into place.

## **⚠️WARNING**

### ***Forward-facing Position Warnings***

---

- If the child weighs more than 18 kg (40 lbs) or their shoulders are above the highest harness level, you **MUST** use this child restraint as a booster (p. 28).
- Adjust, or remove, the **vehicle** headrest, **in the seat where the child restraint is to be fastened**, so that the back of the child restraint rests against the vehicle seat back.
- The headrest on the vehicle seat in front of the child should be put in its lowest position. The vehicle seat back that the child faces must be fully padded and free of any hard objects.

### ***Seat Belt Warnings***

---

#### ***For 5-point Harness Use Only***

- **DO NOT** use this child restraint if it moves more than 25 mm (1 inch) forward or side-to-side at the vehicle belt path. Serious injury or death may result from poor installation. If you cannot tightly secure the child restraint, try again or move it to another location.

#### ***For Both 5-point Harness and Booster Use***

- **DO NOT** use this child restraint in a vehicle with door-mounted seat belts.
- **DO NOT** use this child restraint in a vehicle with seat belts that automatically move along the vehicle frame when the door is opened. These seat belts will not hold a child restraint properly.
- If the vehicle seat belts are not routed and fastened correctly, the child restraint may not protect the child in a crash.
- **DO NOT** allow the seat belt release button to touch the child restraint. Accidental contact may cause the seat belt to release. If necessary, turn the seat belt release button away from the child restraint or move the child restraint to a different location.
- Failure to adjust the harness or vehicle seat belts snugly around the child may result in the child striking the vehicle's interior during a sudden stop or crash. Serious injury or death may occur.

## **⚠️WARNING**

### ***For Booster Use Only***

- When using this booster seat, **NEVER** use a lap belt only. You **MUST** use vehicle seat belts that have a lap/shoulder combination.
- The shoulder belt **MUST** be threaded properly (p. 36).
- **DO NOT** use this booster seat if the child's ears are above the back of the booster seat headrest.
- The shoulder belt **MUST NOT** cross the child's neck **or** fall off the child's shoulder. If you cannot adjust the shoulder belt to **properly lay midway between the child's shoulder and neck AND at or above the shoulder**, try another seating location or do not use the booster seat.

### ***LATCH Warnings***

---

#### ***For 5-point Harness Use Only***

- This LATCH system is intended to be used **ONLY** as described in these instructions. Serious injury or death may result from misuse.
- In addition to these instructions, read and follow your vehicle owner's manual regarding installation of the child restraint and LATCH. If there is a discrepancy, follow your vehicle owner's manual.
- **ONLY** use for securing child restraint to vehicle lower anchor bars.
- **NEVER** attach two lower anchor connectors to one vehicle lower anchor bar.
- **NEVER** use the vehicle seat belts when using the lower anchor connector assembly. Using both together can cause slack in a sudden stop or crash.
- When not in use, the lower anchor connector assembly should be securely stored on child restraint. Keep out of reach of children.

## **⚠WARNING**

### **LATCH Warnings – cont.**

#### **For 5-point Harness Use Only**

- **ALWAYS** be sure that the lower anchor connectors are attached to the vehicle lower anchor bars by pulling hard on the lower anchor connectors. If they are not attached, the lower anchor connector assembly will not secure your child restraint. Serious injury or death may result.
- **DO NOT** use this child restraint if it moves more than 25 mm (1 inch) side to side or front to back at either the rear-facing or forward-facing belt path on the child restraint. Serious injury or death may result from poor installation. If you cannot tightly secure the child restraint, try again or move it to another location.

#### **Tether Strap Warnings**

- To avoid a strangulation hazard, you **MUST** tightly roll or fold excess or unused tether strap and secure with a rubber band. Attach the tether hook to the storage clip when not in use (p. 13). This will keep an unused tether from hitting someone during a crash.

#### **Additional Warnings**

- In hot or sunny weather, **ALWAYS** check the areas of the child restraint that may contact your child (e.g., buckle, buckle tongues, etc.) for hot areas before placing him/her into the child restraint. The child could be burned. Cover the child restraint with a light colored blanket when you leave the vehicle.
- This child restraint must be securely fastened to the vehicle, **even when unoccupied**, using the vehicle seat belts or lower anchor connectors. An unsecured child restraint may injure someone if a crash occurs.
- **DO NOT** use the cup holders to store cans or hard cups. Only for use with soft cups (such as styrofoam or paper).
- **DO NOT** place any cups that contain hot liquids in the cup holders.
- **DO NOT** attach additional padding, toys, or other devices not made by Evenflo or described in these instructions for the child restraint. Items not tested with the child restraint could injure the child.

## **⚠WARNING**

Additional pads or pillows may interfere with the function of the harness system, or cause breathing problems if the child's head falls forward, increasing the risk of serious injury or death.

- Failure to follow installation instructions could result in serious injury or death. These instructions and the instructions in your vehicle owner's manual must be followed carefully. If there is a conflict between the two, the vehicle owner's manual regarding child restraint installation must be followed.
- In cold weather, **DO NOT** dress the child in bulky clothing like snowsuits if the child is riding in a child restraint. Bulky coats/snowsuits make it difficult to properly tighten the harness to the child, which may allow the child to be ejected from the restraint during a crash. If necessary, place a blanket over the harnessed child without interfering with the child restraint harness system.

## Safe Practices

---

- **Everyone rides buckled up or the vehicle does not go.** Make no exceptions for adults or children. If someone unbuckles, stop the vehicle. Being firm and consistent from the start will mean fewer discipline problems as children get older. An unrestrained person can be thrown into and injure other passengers.
- **NEVER** try to tend to a crying baby's needs while driving. **NEVER** take a baby out of a child restraint for comforting while the vehicle is moving.
- **DO NOT** allow a child in a vehicle to have objects such as lollipops or ice cream on a stick. The object can injure the child if the vehicle swerves or hits a bump.
- **DO NOT** feed an infant who is riding in a child restraint.
- Put sharp or heavy items in the trunk. Anything loose can be deadly in a crash.

## Motor Vehicle/Aircraft Usage

---

**When used with the 5-point harness system and properly installed pursuant to these instructions,** this restraint is certified for use only in passenger and multi-purpose passenger motor vehicles, buses, and trucks equipped with Type I or II seat belts and in aircraft.

**When used without the 5-point harness system (in booster mode) and properly installed pursuant to these instructions,** this restraint is certified for use only in passenger and multi-purpose passenger motor vehicles, buses, and trucks equipped with Type II seat belts. In booster mode, this restraint is **NOT** certified for aircraft use. A belt-positioning booster requires the use of a lap/shoulder belt system, which is not available on aircraft. Refer to page 39 for instructions on installing your child restraint in aircraft.

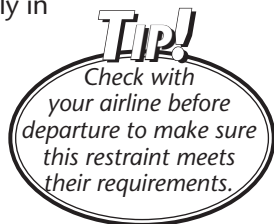

## Recall Information for U.S. Customers

---

- Child restraints could be recalled for safety reasons. You must register this restraint to be reached in a recall. Send your name, address, the restraint's model number, and manufacturing date to

**Evenflo Company, Inc.,  
1801 Commerce Dr.,  
Piqua, OH 45356**  
or call 1-800-233-5921.

You may also register on-line at:

**[www.evenflo.com/registercarseat](http://www.evenflo.com/registercarseat)**

- For recall information, call the U.S. Government's Vehicle Safety Hotline at 1-888-327-4236 (TTY:1-800-424-9153), or go to:

**<http://www.NHTSA.gov>**

## Public Notice for Canadian Customers

---

- To register your child restraint, return your registration card, call 1-937-773-3971, or on-line at **[www.evenflo.com/registercarseatcanada](http://www.evenflo.com/registercarseatcanada)**
- For recall information, call Transport Canada at 1-800-333-0510 (1-613-993-9851 in Ottawa region) or Evenflo at 1-937-773-3971.

## LATCH Information

---

**"LATCH"** (Lower Anchorage and Tether for **CH**ildren) is a system for attaching the child restraint to your vehicle seat. It can be used in place of the seat belts in vehicles with **LATCH** anchors. Refer to your vehicle owner's manual for the locations of **LATCH** anchors.

**Note:** Your vehicle owner's manual may refer to this system as **"ISOFIX"** or **"Universal Anchorage System (UAS)."**

## Care and Cleaning

- **DO NOT** lubricate or immerse the LATCH connectors, the buckle, or any part of this child restraint.
- Plastic and metal parts may be wiped clean with mild soap and water and dried with a soft cloth. Do not use abrasive cleaners or solvents.
- Take care not to damage any labels.
- The harness can be wiped clean with mild soap and water. Allow harness to air dry. **DO NOT** immerse buckle in water.
- The seat pad can be machine washed separately in cold water, delicate cycle, tumble dry 10 – 15 minutes on low heat.
- **NEVER** use child restraint without the seat pad.

**Tip!**

To help protect the vehicle upholstery, place a towel beneath and behind the child restraint.

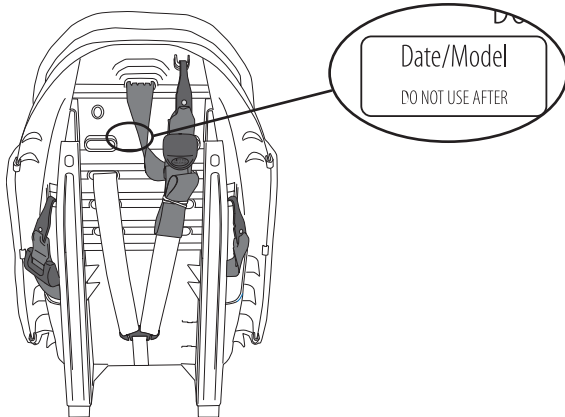

For future reference, record the **model number** of your child restraint AND the **date of manufacture** below (p. 13).

**Model Number:** \_\_\_\_\_

**Date of Manufacture:** \_\_\_\_\_

*This page has been left blank intentionally.*

## Visual Glossary

Your vehicle components may be significantly different than pictured. Consult your owner's manual to help you identify your vehicle components.

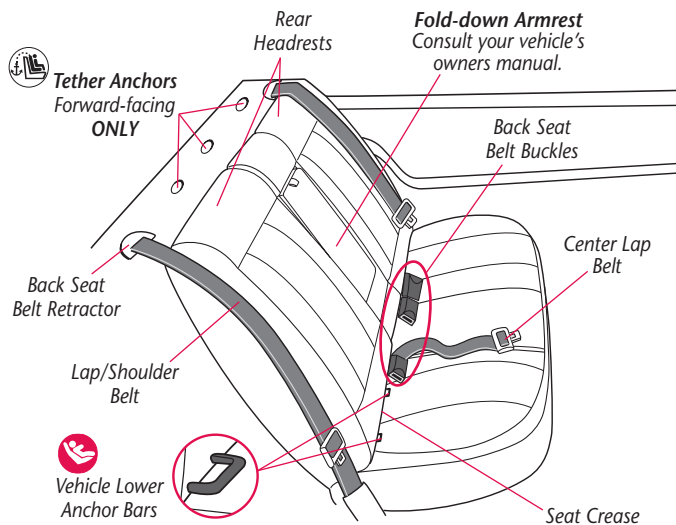

**IMPORTANT:** If your vehicle has **side air bags**, please refer to the warnings on page 2.

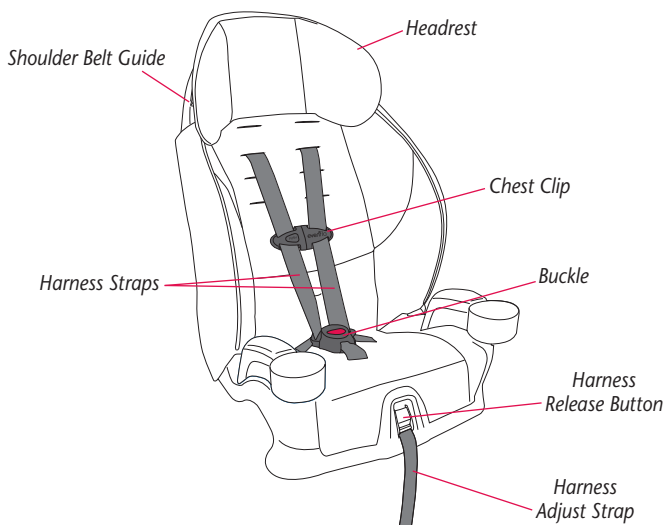

## Visual Glossary

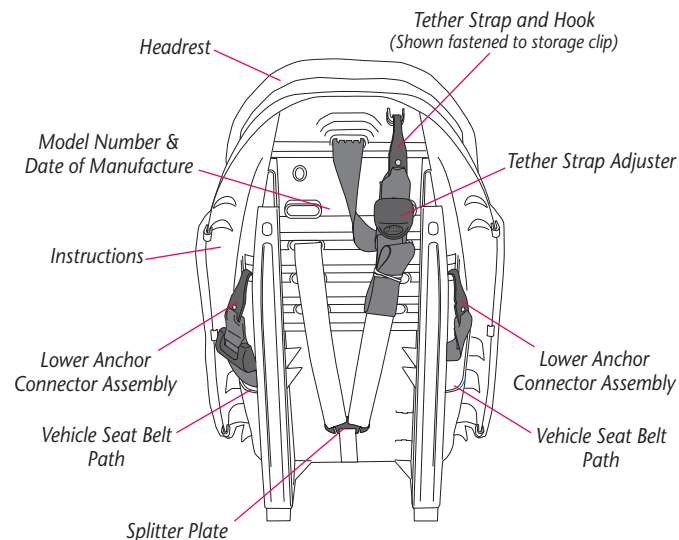
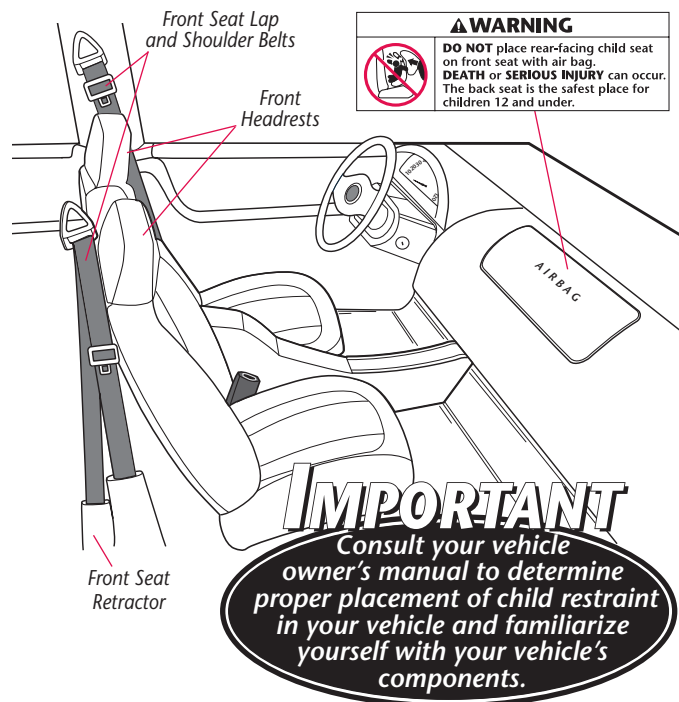



# Using Chase Select/LX with the Internal 5-pt Harness

## Child Requirements

**Weight:** 10 – 18 kg (22 – 40 lbs)

**Height:** 71 – 127 cm (28 – 50 inches) tall, or less, **AND** the tops of the child's ears are at, or below, the top of the child restraint headrest.

**Age:** At least one year old

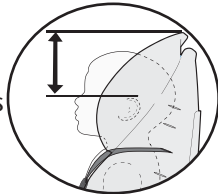

## IMPORTANT

*Evenflo strongly recommends using the top anchorage (tether) strap when using this seat with the internal harness. Using the tether strap will improve the stability of the child restraint and may reduce the risk of injury.*

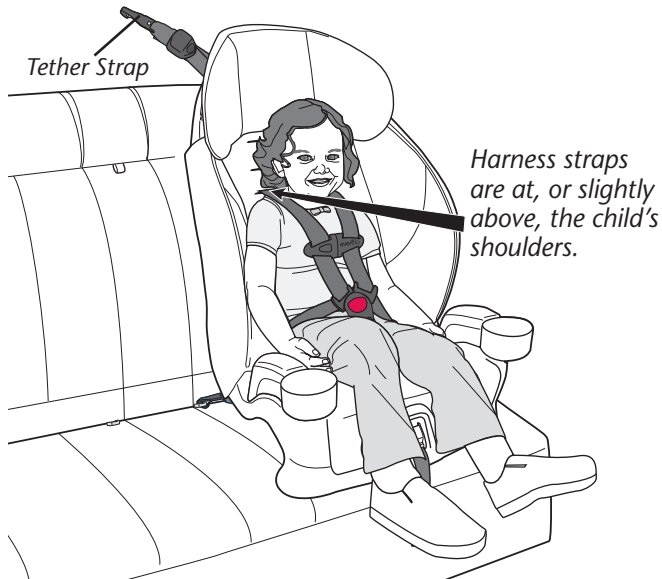

## **WARNING**

If the child weighs more than 18 kg (40 lbs) or their shoulders are above the highest harness level, you **MUST** use this child restraint as a Booster.

## Installation Checklist

### 1. Secure child restraint to the vehicle seat.

- ✓ Locking clip is installed, if necessary (p. 20).
- ✓ Child restraint is securely installed with lower anchor connector assembly (shown at left) through **belt path** (p. 16)

#### OR

- Child restraint is securely installed with vehicle seat belt through **belt path** (p. 19)
- ✓ Tether strap is attached and tightened (p. 18/21).

### 2. Place the child in the child restraint.

- ✓ The child's back and bottom are flat against the back and bottom surfaces of the child restraint.
- ✓ The top of the child's ears **MUST** be at, or below, the top of the child restraint headrest.

### 3. Make necessary adjustments.

- ✓ Harness straps are snug against the child's shoulders, with no slack (p. 23).
- ✓ Crotch strap is properly positioned (p. 27).

### 4. Fasten both buckle tongues.

 Refer to page 22.

### 5. Position and connect chest clip.

- ✓ Chest clip **MUST** be at armpit level (p. 23).

### 6. Check your work.

- ✓ To properly protect the child, the child restraint **MUST NOT** move more than 25 mm (1 inch) from **side-to-side** or from **front-to-back** at the belt path.

## TIP!

To make installation easier, watch the installation video of this child restraint at [www.evenflo.com](http://www.evenflo.com).

## Installation with lower anchor connector assembly

The lower anchor connector assembly that comes with your child restraint will be one of the two types below.

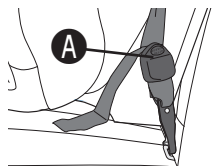

Tilt and slide the adjuster **A** to loosen.

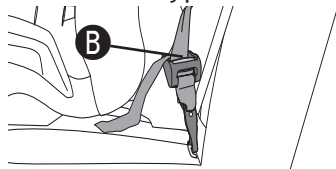

Press the adjuster release button **B** to loosen.

**IMPORTANT:** If you are using the vehicle seat belt to secure the child restraint, **DO NOT** use the lower anchor connector assembly.

### 1. Disconnect tether hook and lower anchor connectors from the back of the child restraint.

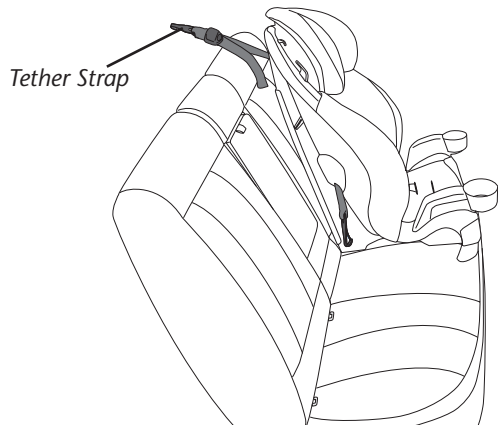
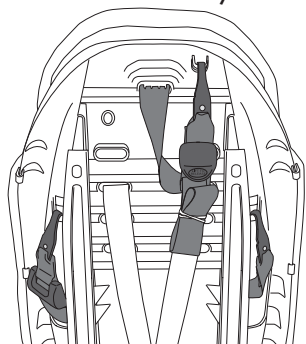

### 2. Place the child restraint in position.

Set child restraint on vehicle seat in forward-facing position.  
Lay the tether strap over the back of the vehicle seat.

## Installation with lower anchor connector assembly

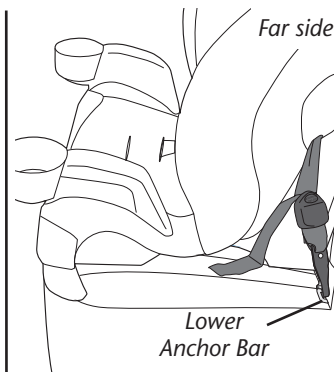
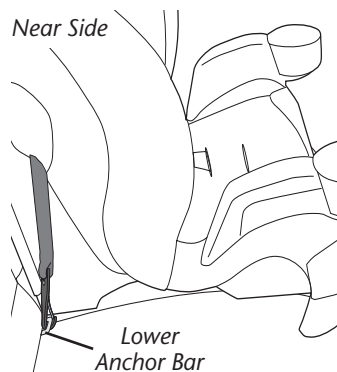

### 3. Attach lower anchor connectors.

Attach a lower anchor connector onto **each** lower anchor bar.

**IMPORTANT:** Make sure both lower anchor connectors are facing upward and the harness straps are not twisted.

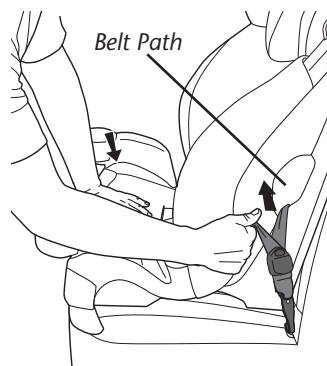

### 4. Secure the child restraint.

Using your full weight, push the child restraint firmly into the vehicle seat while pulling up on the lower anchor connector assembly strap to tighten.

**IMPORTANT:** To properly protect the child, the child restraint **MUST NOT** move more than 25 mm (1 inch) from side-to-side or from front-to-back **at the belt path**. If you cannot tightly secure the child restraint, try again or move it to another location.

## Installation with lower anchor connector assembly

The Tether Strap that comes with your child restraint will be one of the two types below.

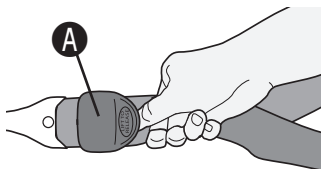

Tilt and slide the adjuster **A** to loosen.

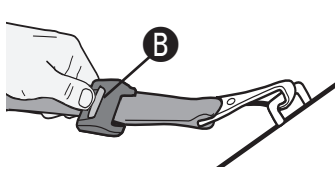

Press the adjuster release button **B** to loosen.

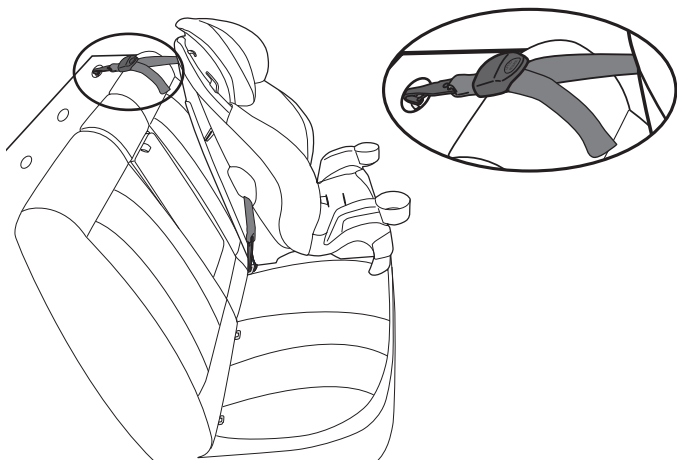

### 5. Connect and tighten tether strap.

Connect the tether hook to the anchor behind the vehicle seat, as shown. (Please consult your vehicle owner's manual, as tether anchor locations may vary.) Pull the strap and tighten the tether securely.

**IMPORTANT:** If your tether strap is too short to reach from the child restraint to your vehicle tether anchor, you will need a Tether Extender. Please call ParentLink (see back cover).

## Installation with Seat Belt

**IMPORTANT:** If you are using the vehicle seat belt to secure the child restraint, **DO NOT** use the lower anchor connector assembly.

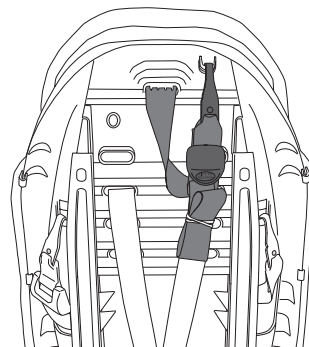

1. Disconnect tether hook from the back of the child restraint.

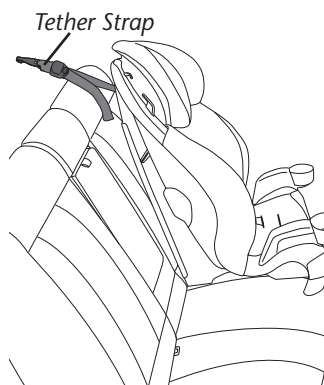

2. Place the child restraint in position.

Set child restraint on vehicle seat in forward-facing position. Lay the tether strap over the back of the vehicle seat.

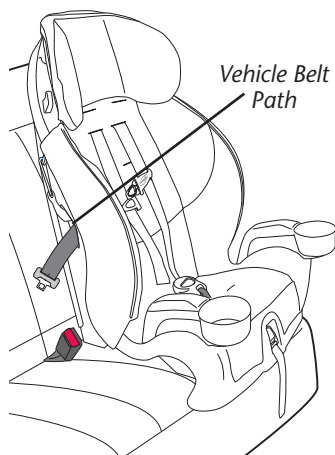

3. Route vehicle seat belt through belt path and buckle it, as shown.

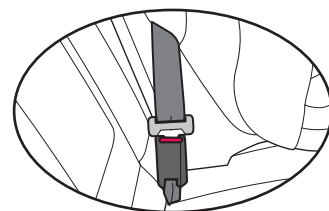

**Note:** Lift the restraint's seat pad away for easier access.

## Installation with Seat Belt

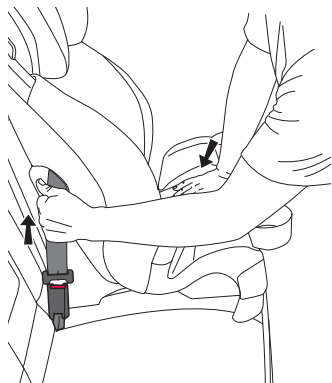

- 4. Remove all slack from the seat belt.**  
Push downward on child restraint while tightening seat belt to remove excess slack.

### 5. Install Locking Clip, if necessary.

If your vehicle was built **prior to model year 1996**, and has either a lap belt or lap/shoulder belt that is equipped with an emergency locking retractor (ELR), you **MUST** use a Locking Clip. Check your vehicle owner's manual to identify which vehicle belt system is in your vehicle.

Locking Clip installed properly.

13 mm  
(0.5 inch)

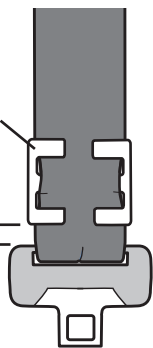

If your vehicle is **model year 1996 or newer**, it likely has a vehicle belt system that can be locked when tightened, and will not require use of a Locking Clip.

**Consult your vehicle owner's manual before installing a Locking Clip.**

If your vehicle requires a Locking Clip, please call ParentLink (see back cover) to obtain a Locking Clip and instructions on how to install and use it.

## **⚠ WARNING**

- Remove Locking Clip from vehicle seat belt when not used with a child restraint, or the vehicle seat belt will not properly restrain an adult or child. Serious injury could occur.
- DO NOT** use a Locking Clip in booster mode.

## Installation with Seat Belt

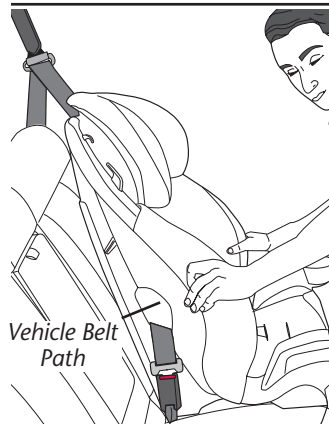

- 6. Ensure child restraint is secure.**  
Try to move the child restraint in all directions.

**IMPORTANT:** To properly protect the child, the child restraint **MUST NOT** move more than 25 mm (1 inch) from side-to-side or from front-to-back **at the vehicle belt path**. If you cannot tightly secure the child restraint, try again or move it to another location.

The Tether Strap that comes with your child restraint will be one of the two types below.

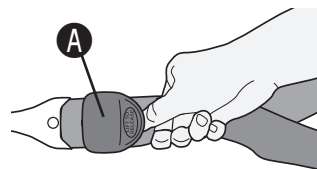

Tilt and slide the adjuster **A** to loosen.

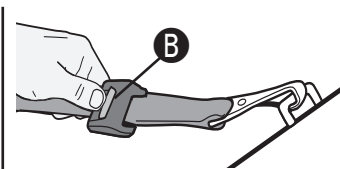

Press the adjuster release button **B** to loosen.

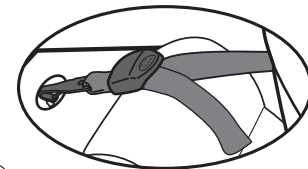
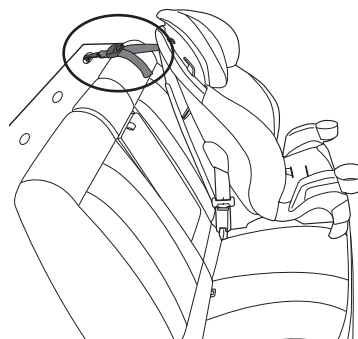

### 7. Connect and tighten tether strap.

Connect the tether hook to the anchor behind the vehicle seat, as shown. (Please consult your vehicle owner's manual, as tether anchor locations may vary.) Pull the strap and tighten the tether securely.

**IMPORTANT:** If your tether strap is too short to reach from the child restraint to your vehicle tether anchor, you will need a Tether Extender. Please call ParentLink (see back cover).

## Securing the Child

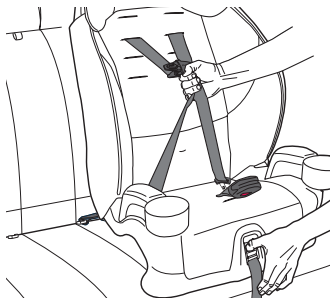

### 1. Loosen harness.

Press the harness release button on the front of the seat while pulling the harness straps.



### 2. Position harness straps.

Unfasten chest clip and place the child in the child restraint. Bring each harness strap over the child's shoulders.

**IMPORTANT:** The child's back and bottom should be flat against the restraint. If there is a gap, the child will not be comfortable.

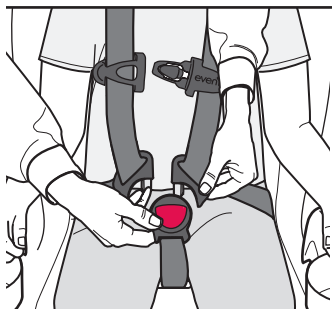

### 3. Buckle the harness.

Insert both buckle tongues into the buckle.  
**Note:** Pull up on the harness straps to ensure that the buckle tongues are fastened securely.

## Securing the Child



### 4. Fasten and adjust chest clip.

Snap the two halves of the chest clip together, as shown, and slide to armpit level.

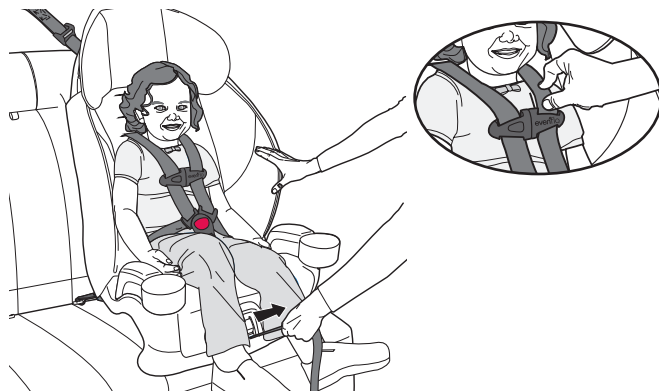

### 5. Tighten harness.

Pull the harness adjuster strap to tighten the harness.

**Note:** Check the harness straps near the shoulders for slack. You should **NOT** be able to pinch the harness (see illustration). Adjust as needed.

**IMPORTANT:** A snug strap should not allow any slack. It lies in a relatively straight line without sagging. It does not press on the child's flesh or push the child's body into an unnatural position. Check the harness straps near the shoulders for slack and adjust as needed.

## Removing the Child

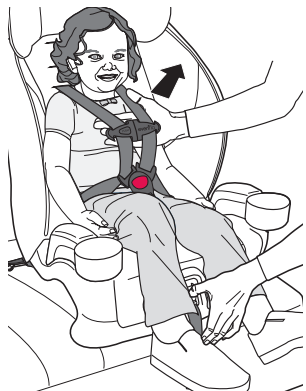

### 1. Loosen harness straps.

Press the harness release button on the front of the seat while pulling the harness strap outward behind the fastened chest clip.



### 2. Disconnect chest clip.

Push the release button and pull the chest clip apart.

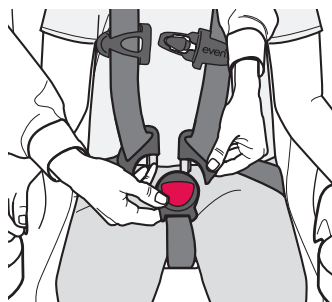
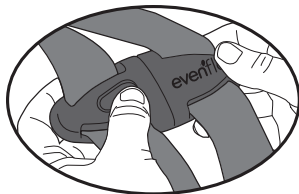

### 3. Unbuckle harness.

Press the red button on the buckle and release both buckle tongues.

You may now remove the child.

## Positioning the Harness Strap

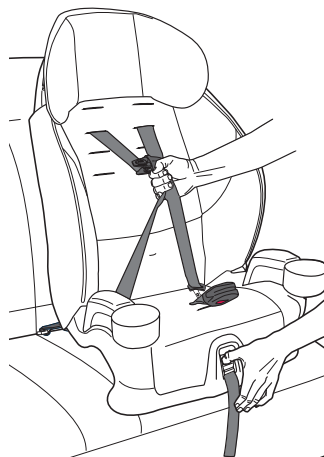

### 1. Loosen harness straps.

Press the harness release button on the front of the seat while pulling the harness straps.

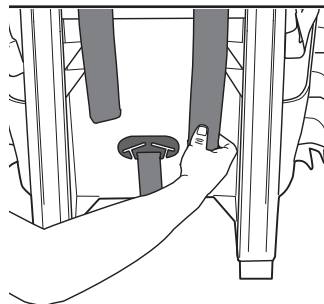

### 2. Remove both Harness Straps from the Splitter Plate.

## Positioning the Harness Strap

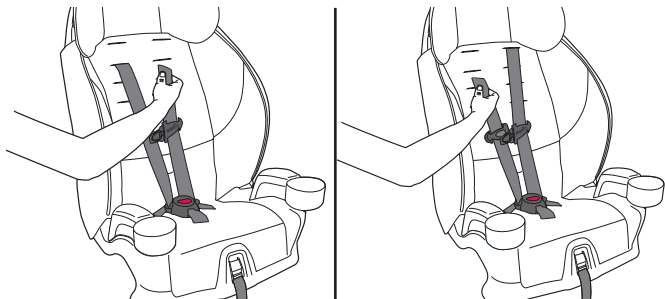

### 3. Move harness strap.

Remove both harness straps from the slots and feed them into the new slot, as shown. Pull the harness strap to the back of the child restraint.

**Note:** Straps must be positioned at the child's shoulder level or in the closest position slightly above.

**IMPORTANT:** When inserting harness straps through the slots in the seat pad, make sure you route them correctly through their corresponding slots in the seat shell.

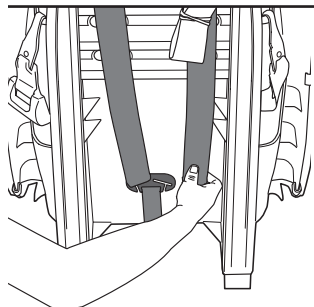

### 4. Attach Harness Straps to Splitter Plate.

Attach the loop at the end of each harness strap onto the splitter plate.

**IMPORTANT:** Make sure both harness straps are installed completely on the splitter plate, as shown.

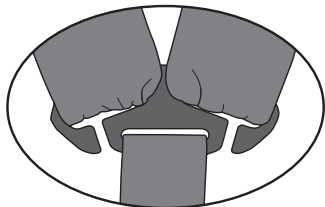

## Positioning the Crotch Strap

As your child grows, you will need to change the crotch strap position so that it is in the slot closest to your child. The crotch strap should **ALWAYS** be as close as possible to, but **NEVER** under, the child's bottom.

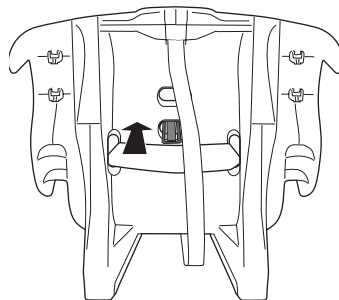

### 1. Remove Crotch Strap.

Loosen the harness straps and move them out of the way. Push the anchor up through the slot to the top of the seat.

### 2. Insert Crotch Strap into new slot.

Insert the crotch strap anchor into the slot that is the closest to the child **AND** the most comfortable for the child. Pull the crotch strap to make sure it is secure.

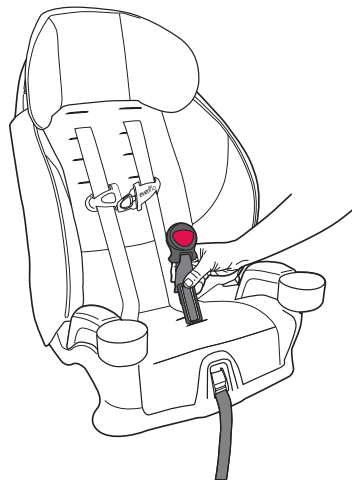

# When to Put Your Child in a Booster Seat

Booster seats raise the child up and help to position the vehicle lap and shoulder belt correctly. When the child is **properly restrained** in a booster seat, their risk of injury in all types of crashes is reduced, as the lap and shoulder belt provides excellent restraint of both the upper and lower torsos.

**It is important for the child to sit properly within the vehicle seat belts.** When the vehicle seat belt is buckled, the lap belt should be low on the hips, just touching the thighs, and the shoulder belt should lie across the middle of the shoulder. If the child leans out or moves the belt behind the back or places it under the arm, **it will not provide the intended restraint.**

There are a number of things to consider when deciding whether the child is ready to sit in a booster seat, including: the weight and height rating on their current child seat, the child's own weight and height, their maturity, and the seating positions available in your vehicle.

## How is a booster seat used?

Using a booster seat is very similar to buckling yourself into the vehicle:

- Read the instruction manuals for both the booster seat and the vehicle before you start.
- Put the booster in the back seat in a location with a lap and shoulder belt. **Never use a booster with only a lap belt**, as this could cause serious injuries.
- After the child is in the booster, pull the lap and shoulder belt across him/her and buckle it.
- Check that the shoulder belt lies across the middle of the shoulder and that the lap belt is low on the hips, just touching the thighs.

## How can you tell if your child is ready to transition to a booster seat?

You should consider using a booster seat if the following conditions apply:

- The child is mature enough to sit in the booster seat and not put the belts under their arm or behind their back.
- The child is approaching the weight or height limit of the child restraint they are currently using.
- If you have a vehicle that does not have a tether anchorage but has lap/shoulder belts available in the back seat, a booster seat may provide better protection than an internal harness seat without the tether.

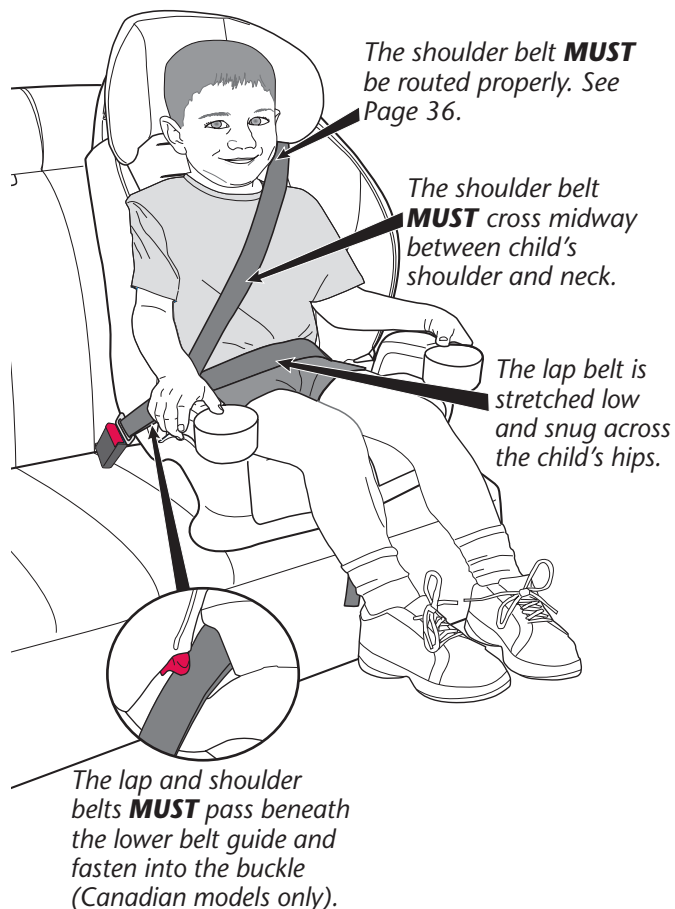



# Using as a Booster Seat

## Child Requirements

**Weight:** 18 – 49.8 kg (40 – 110 lbs)

**Height:** 110 – 145 cm (43.3 – 57 inches)

tall **AND** the tops of the child's ears are at, or below, the top of the child restraint headrest.

**Age:** At least four years old

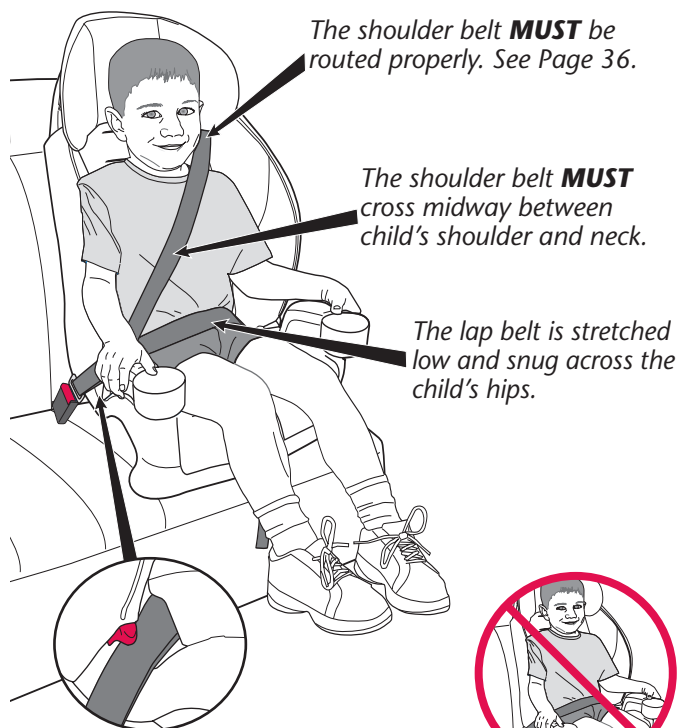
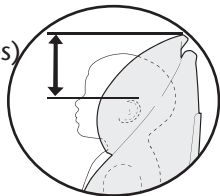

The shoulder belt **MUST** be routed properly. See Page 36.

The shoulder belt **MUST** cross midway between child's shoulder and neck.

The lap belt is stretched low and snug across the child's hips.

The lap and shoulder belts **MUST** pass beneath the lower belt guide and fasten into the buckle (Canadian models only).

## IMPORTANT

Always secure the booster seat with the lower anchor connectors or vehicle seat belt when not occupied. An unsecured booster seat can fly into and injure other occupants in the event of a crash.

## Booster Installation Checklist

### 1. Convert child restraint to booster seat.

See "Converting into a Booster Seat," p. 32.

### 2. Secure booster seat to the vehicle seat.

✓ Make sure the bottom and back of the booster seat are touching vehicle seat and back.

✓ Level the booster seat (Canadian models only), p. 37.

**IMPORTANT:** You may use the tether strap and lower anchor connectors to secure this booster seat to the vehicle seat as long as the position of the booster seat in the vehicle and/or the resulting fit of the vehicle seat belt over the child **are not affected**.

### 3. Place the child in the booster seat.

Make sure the child's back and bottom are flat against the back and bottom surfaces of the booster seat.

### 4. Secure child and booster seat to vehicle seat.

✓ Stretch the lap/shoulder belt across the child and fasten the buckle.

✓ The shoulder belt **MUST** be routed properly (p. 36).

✓ Make sure the shoulder and lap belts are threaded under the red lap belt guide (Canadian models only).

### 5. Check your work.

Make sure the lap belt is stretched low and snug across the child's hips, within the belt guides, and fastened into the buckle. The shoulder belt must cross the child midway between his/her shoulder and neck.

## ⚠ WARNING

- The shoulder belt **MUST NOT** cross the child's neck or fall off the child's shoulder. If you cannot adjust the shoulder belt to properly lay midway between the child's shoulder and neck **AND** at or above the shoulder, try another seating location, or do not use the booster seat.



**Tip!** To make installation easier, watch the installation video of this booster seat at [www.evenflo.com](http://www.evenflo.com).

## Converting into a Booster Seat

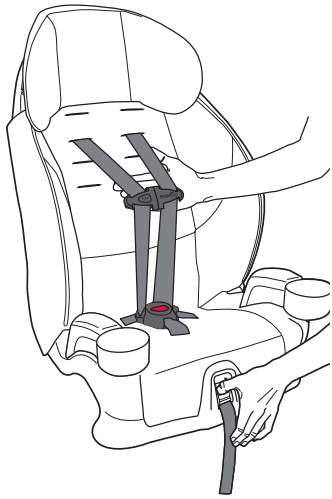

- 1. Loosen harness.**  
Press the harness release button while pulling outward on the harness straps, as shown. Disconnect the chest clip.

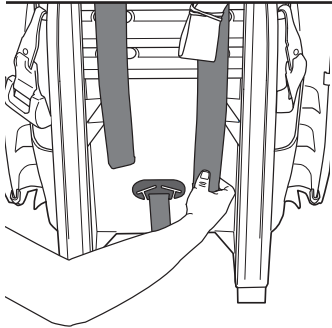

- 2. Remove both Harness Straps from the Splitter Plate and pull them through to the front of the seat.**

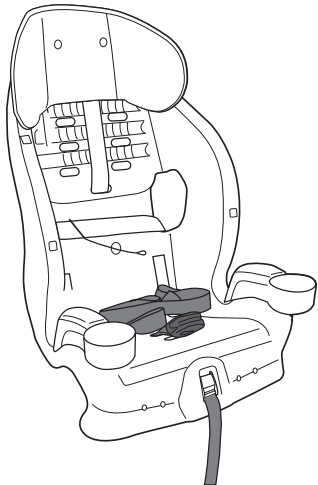

- 3. Disconnect all J-clips and all Retaining Strips, then remove the Seat Pad.**

## Converting into a Booster Seat

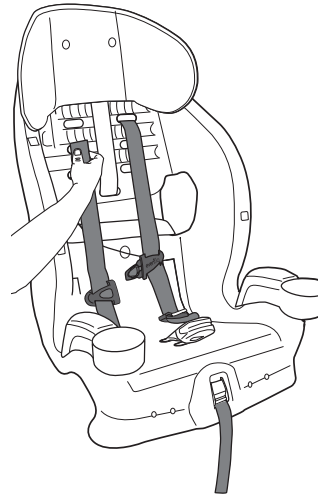

- 4. Route the Harness Straps through Adjustment Slots, then attach to Splitter Plate.**

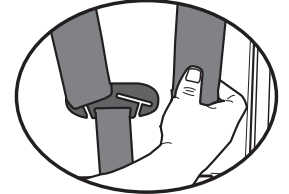

**IMPORTANT:** Make sure both harness straps are installed completely on the splitter plate.

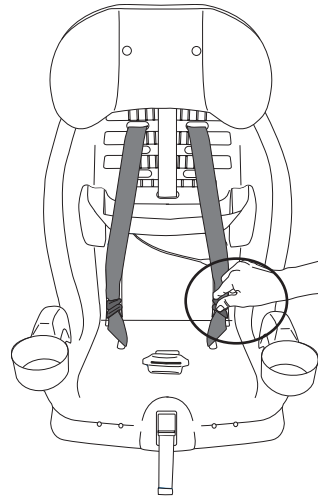

- 5. Tuck the Chest Clip and Buckle Tongues into the recesses on either side of the seat shell.**

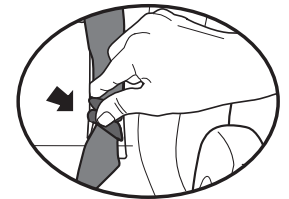

## Converting into a Booster Seat

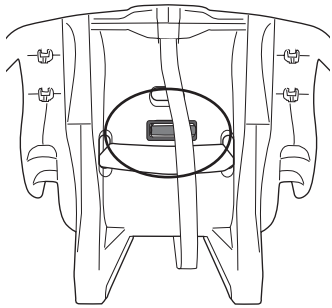

### 6. Remove the Crotch Strap.

Locate the crotch strap anchor on the bottom. Turn the anchor sideways and push it through the seat shell to remove, as shown.

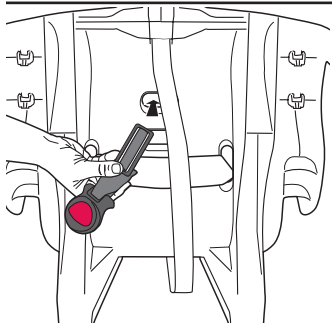
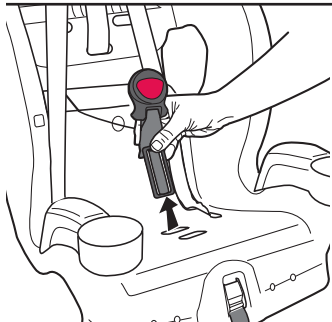
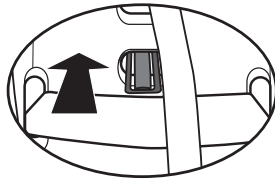

Insert the crotch strap anchor back into the opening from the bottom of the child restraint.

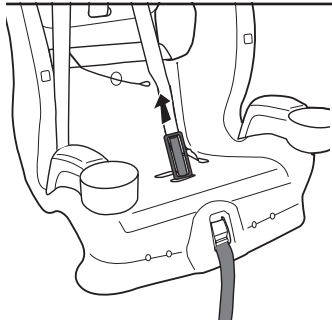

Pull the anchor through the seat and adjust so it lies flat.

## Converting into a Booster Seat

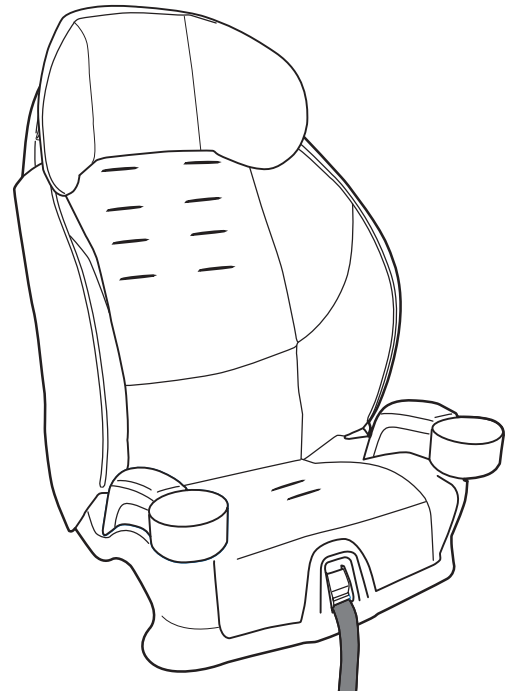

### 7. Install the Seat Pad.

Your child restraint is now in Booster Mode and ready for a child who weighs 18 – 49.8 kg (40 – 110 lbs), is 110 – 145 cm (43.3 – 57 inches) tall, and is at least four years old. Make sure the tops of their ears are below the top of the child restraint headrest.

**Note:** to convert the seat back into 5-point harness mode, reverse these steps.

## Shoulder belt routing while in booster mode

While the seat is used in booster mode the shoulder belt must be routed over the child's shoulder.

The belt must pass under the head rest, between the head rest and the seat as long as the child's shoulders are at or below the opening between the head rest and shell.

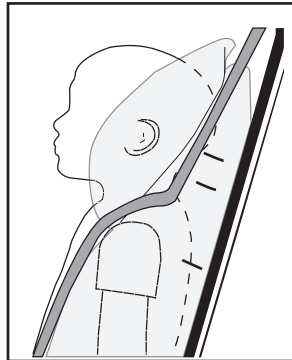

If the child's shoulders are high enough that routing the shoulder belt under the head rest causes the belt to be pulled down the back side of the child's shoulder (before passing through the head rest), the belt should not be routed between the seat and the head rest.

If the shoulder height causes the belt to route behind the back and the top of the ears are still at or below the top of the head rest, the shoulder belt should be routed on top of the head rest.

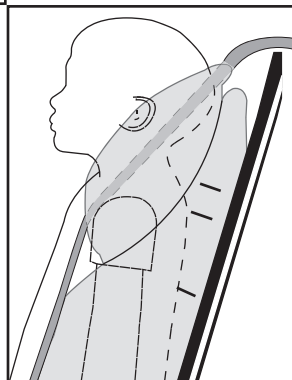

## General Information

### Leveling the Booster Seat

Canadian Models Only

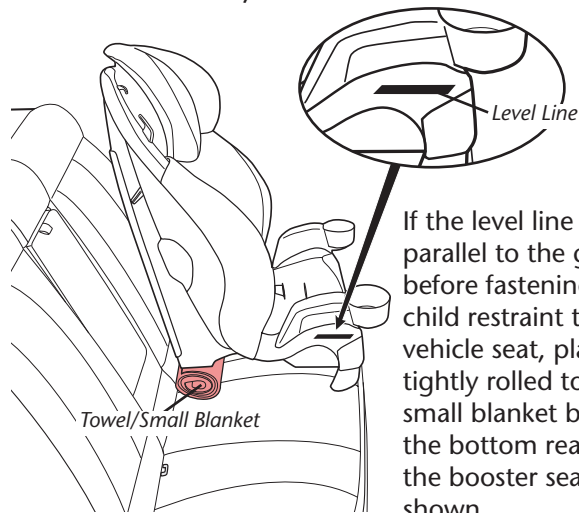

If the level line is not parallel to the ground, before fastening the child restraint to the vehicle seat, place a tightly rolled towel/small blanket beneath the bottom rear of the booster seat, as shown.

### Installing the Cup Holders

Not available on all models.

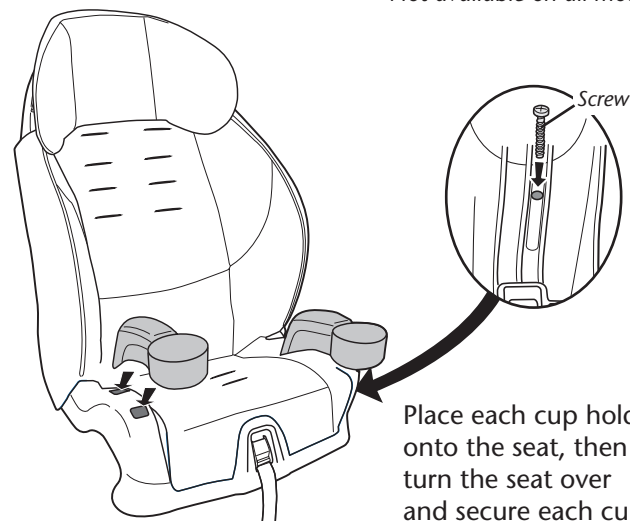

Place each cup holder onto the seat, then turn the seat over and secure each cup holder with a screw, as shown. **Do not over tighten.** Make sure each cup holder is attached securely in place.

## Removing Seat Pad

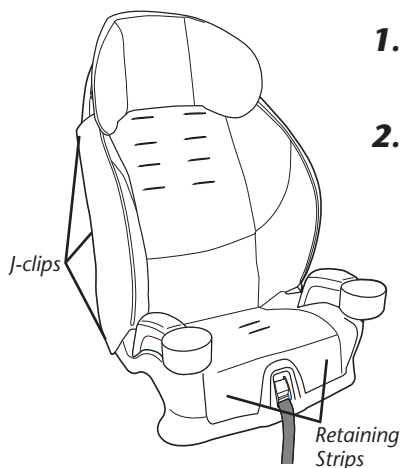

1. Disconnect the harness straps from the splitter plate.
2. Disconnect J-clips and two retaining strips. Remove the seat pad.

## Securing Your Child Restraint in Aircraft

The Federal Aviation Administration (FAA) recommends that you secure your child for air travel in an appropriate child restraint based on your child's weight and size. Turbulence can happen with little or no warning. When turbulence occurs, **the safest place for your child is in a properly installed child restraint, not in an adult's lap or on the aircraft seat with its seat belt.** Keeping your child in a child restraint during the flight will help ensure your family arrives safely at your destination.

The FAA recommends that a child weighing:\*

- more than 18 kg (40 lbs) use an aircraft seat belt;
- less than 9 kg (20 lbs) use a rear-facing child restraint; and
- from 9 to 18 kg (20 to 40 lbs) use a forward-facing child restraint.

**\* Please note that these FAA recommendations may vary from those applicable to the use of your child restraint in a motor vehicle.**

### **IMPORTANT**

*You must use the internal harness when installing the child restraint in aircraft.*

## Installing Child Restraint in Aircraft

**IMPORTANT:** Before installing the child restraint, make sure the **aircraft seat is in a fully upright position.**

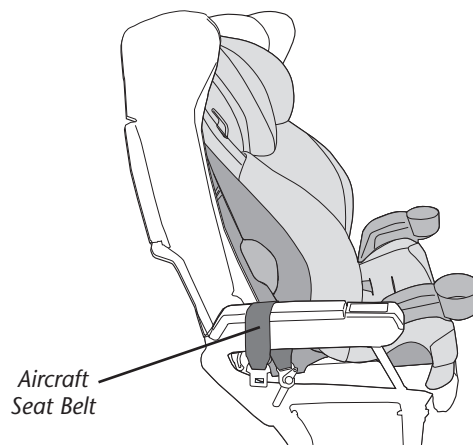

1. **Place the child restraint in position.**  
Place the child restraint on the aircraft seat forward-facing, as shown above.

## Installing Child Restraint in Aircraft

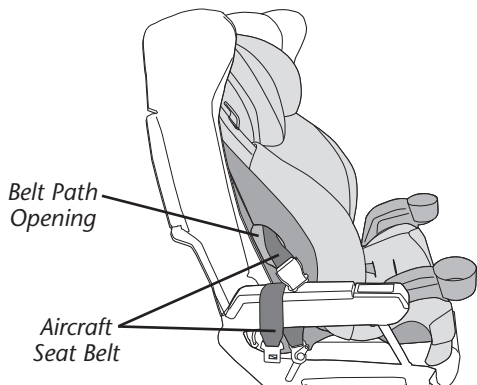

### 2. Route aircraft seat belt through belt path.

Route the aircraft seat belt through the belt path opening in the back of the child restraint and continue through the opening on the opposite side of the child restraint.

**Note:** Lift the restraint's seat pad away for easier access.

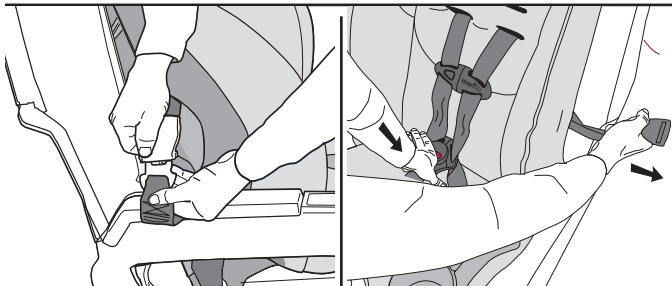

### 3. Fasten the aircraft seat belt, then remove all slack from the belt.

The aircraft seat belt must be as tight as possible. Route the excess aircraft seat belt strap back through the belt path opening. Using your full weight, push the child restraint firmly onto the aircraft seat while pulling on the excess seat belt strap to tighten.

**Note:** Because of the fixed length of aircraft seat belts, the belt buckle could be behind the child's back after tightening the belt. For your child's comfort, Evenflo recommends cushioning the child's back by placing a small pillow or folded-up blanket, or a folded-up jacket, over the belt buckle.

**Check your work:** Reconnect the seat pad to the front of the child restraint. Try to move the child restraint in all directions. If you can move the restraint more than 25 mm (1 inch) from side-to-side or front to back **at the belt path**, the aircraft seat belt is not tight enough, and you **MUST** install again until the seat belt is tight.

## Replacement Parts

Not available on all models.

You can order replacement parts on-line at [www.evenflo.com](http://www.evenflo.com) or contact Evenflo. When you contact us, please have the product model number and date of manufacture (found on the back of the child restraint).

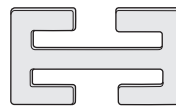

Locking Clip:  
Not included with  
child restraint, see  
page 20.

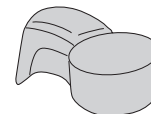

Cup Holder/Armrest



Head Pillow

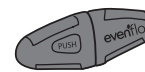

Chest Clip

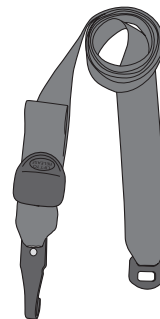

Tether Extender

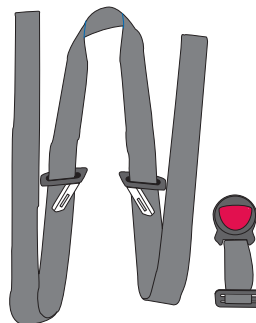

Harness System

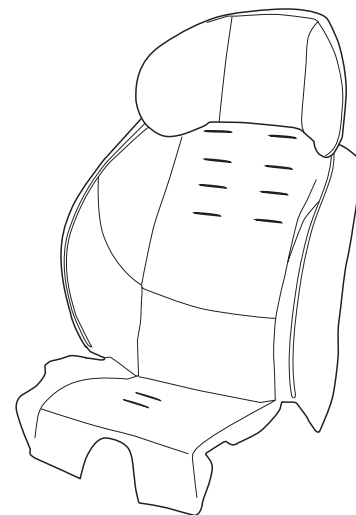

Seat Pad

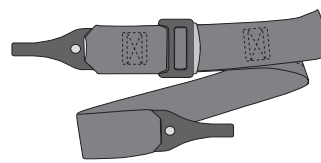

Lower Anchor  
Connector Assembly

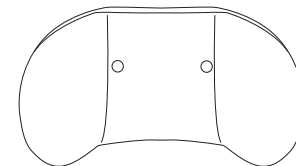

Head Foam

## Proper Disposal of this Child Restraint

At the end of this child restraint's useful life, Evenflo encourages you to dispose of it properly. Most of the components in this child restraint are recyclable.

1. Remove all fabric and padding.
2. Remove all screws and disassemble the restraint.
3. Recycle all plastic/foam parts and discard the rest.

If your local recycling center won't accept the padding, you may dispose of it in the landfill.

**Note:** Evenflo uses recycled materials in the manufacturing process whenever possible but never for components that are critical for safety.

*To prevent injury due to hidden damage, lost instructions, outdated technology, etc., discontinue use of this restraint after date on the Date/Model label (below), **OR** if it has been involved in a crash.*

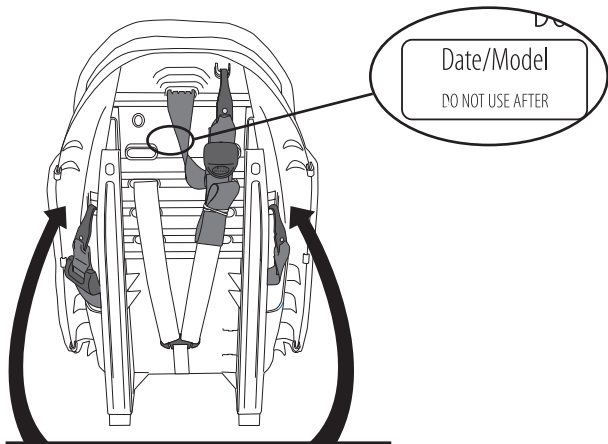

*After thoroughly reading and following these instructions, store them in the slots on either side of the child restraint.*

## Limited Warranty

For a period of 90 days from the original purchase of this Product, Evenflo warrants to the original end user ("Purchaser") this Product (including any accessories) against defects in material or workmanship. Evenflo's sole obligation under this express limited warranty shall be, at Evenflo's option, to repair or replace any Product that is determined to be defective by Evenflo and determined to be covered by this warranty.

Repair or replacement as provided under this warranty is the exclusive remedy of the Purchaser. Proof of purchase in the form of a receipted invoice or bill of sale evidencing that the Product is within the warranty period must be presented to obtain warranty service. This express limited warranty is extended by Evenflo ONLY to the original Purchaser of the Product and is not assignable or transferable to subsequent purchasers or end users of the Product. For warranty service, contact Evenflo's ParentLink Consumer Resource Center.

EXCEPT TO THE EXTENT PROHIBITED BY APPLICABLE LAW, ANY IMPLIED WARRANTY OF MERCHANTABILITY OR FITNESS FOR A PARTICULAR PURPOSE ON THIS PRODUCT IS HEREBY DISCLAIMED. EVENFLO SHALL NOT BE LIABLE FOR ANY INCIDENTAL, CONSEQUENTIAL, SPECIAL OR PUNITIVE DAMAGES OF ANY KIND FOR BREACH OF THE EXPRESS LIMITED WARRANTY ON THIS PRODUCT, OR ANY WARRANTY IMPLIED BY OPERATION OF LAW. OTHER THAN THE EXPRESS LIMITED WARRANTY SET FORTH ABOVE, THERE ARE NO OTHER WARRANTIES THAT ACCOMPANY THIS PRODUCT AND ANY ORAL, WRITTEN OR ANY OTHER EXPRESS REPRESENTATION OF ANY KIND IS HEREBY DISCLAIMED.

**ParentLink®**

answers. advice. affirmation.™

[www.evenflo.com](http://www.evenflo.com)

USA: 1-800-233-5921, 8 AM to 5 PM E.T.

Canada: 1-937-773-3971

Mexico: 01-800-706-12-00





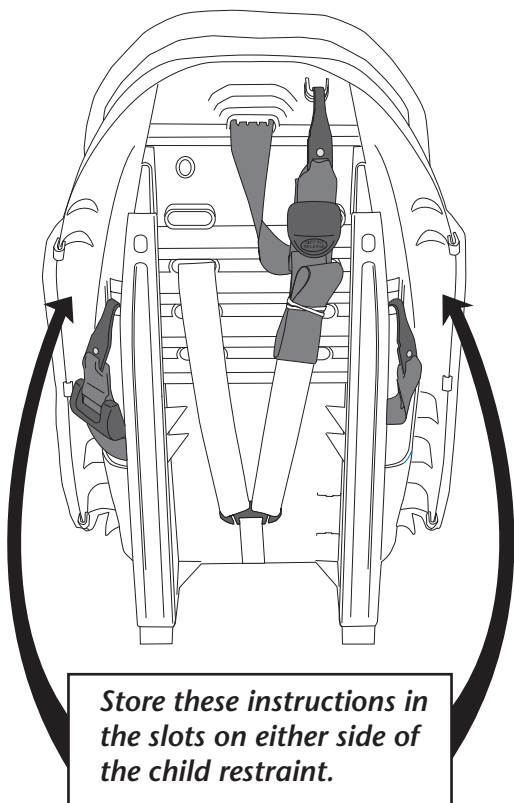

*Store these instructions in the slots on either side of the child restraint.*

**INSTRUCTIONS**

**ParentLink®**

answers. advice. affirmation.™

**[www.evenflo.com](http://www.evenflo.com)**

**USA: 1-800-233-5921, 8 AM to 5 PM E.T.**

**Canada: 1-937-773-3971**

**Mexico: 01-800-706-12-00**